

DESCRIPTION	
CODE	FINISH
PC225SSLAS	STAINLESS STEEL
PC225SSLAS316	STAINLESS STEEL

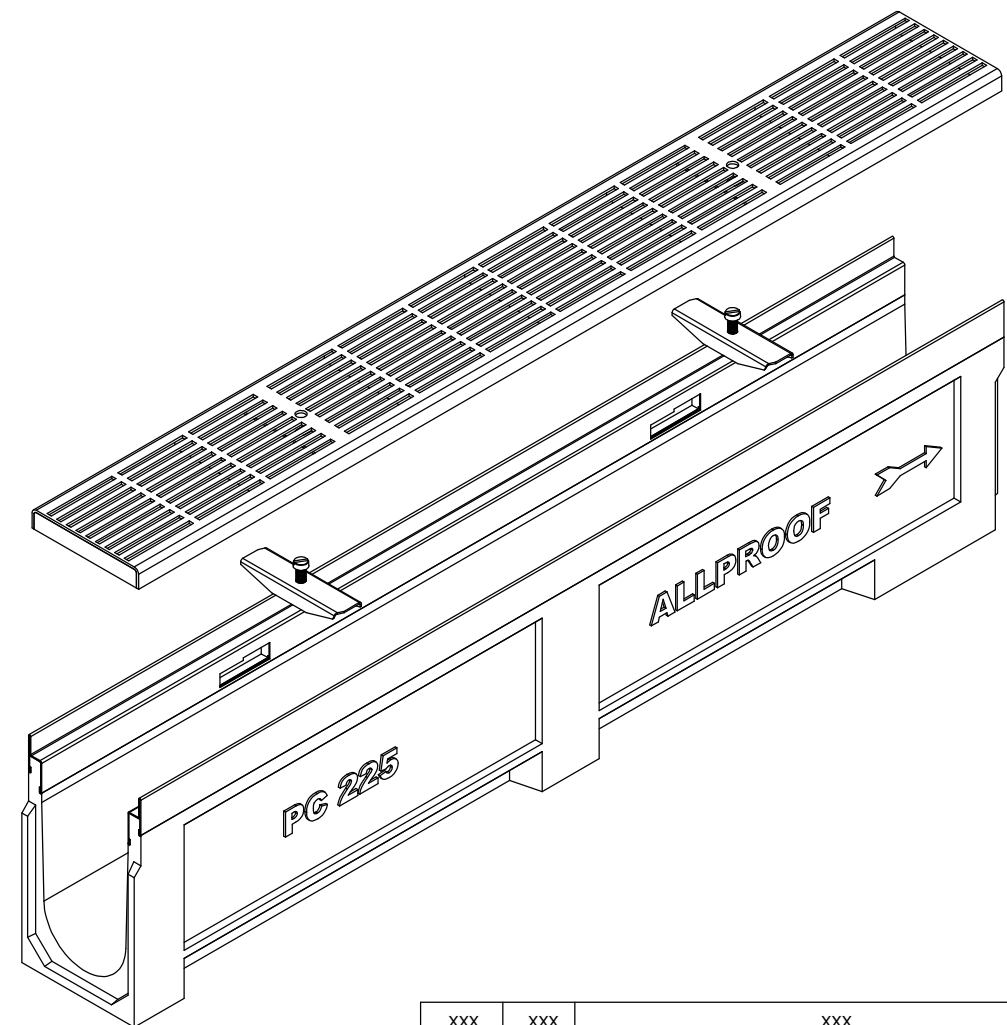
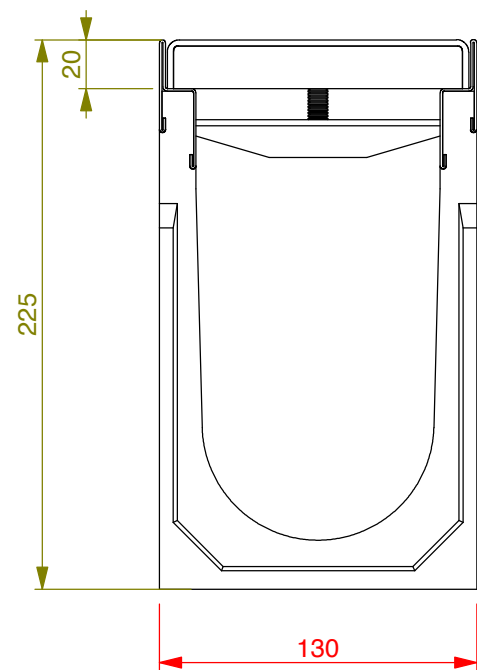
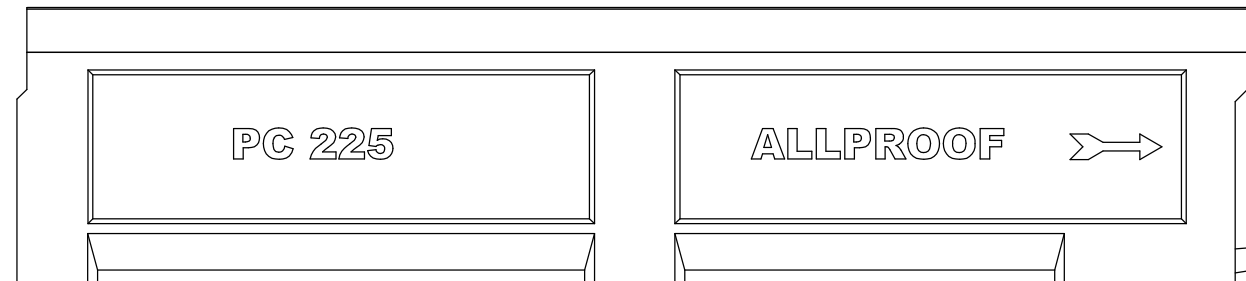
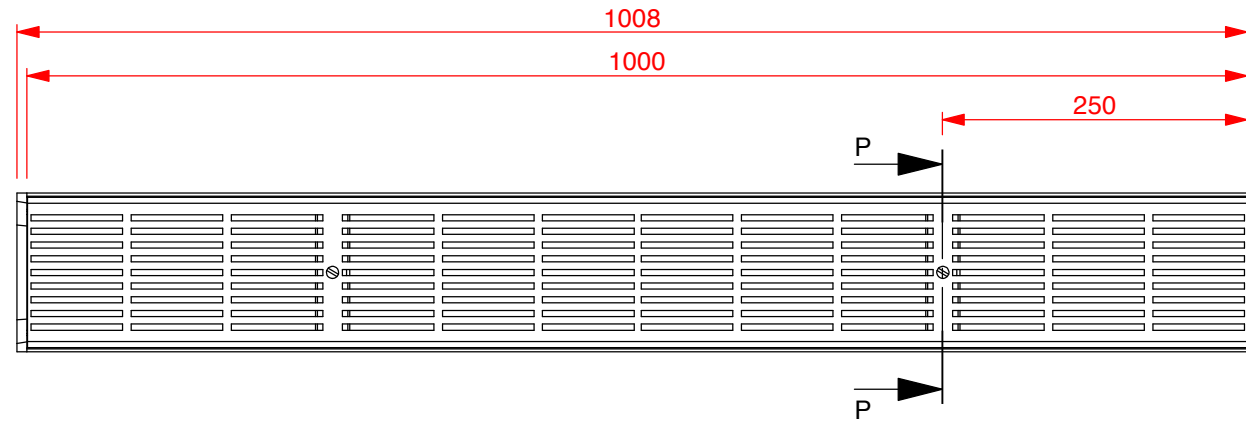
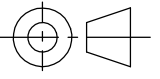

XXX	XXX	XXX	SL	XXX
REVISION	CHANGE	DESCRIPTION	DRAWN	DATE
DO NOT SCALE DRAWING		TITLE		
REQUESTED	XXX	DATE	XXX	PC225 CHANNEL SS LAS GRATE
DRAWN	S.L.	DATE	XXX	
APPROVED		DATE		APPLICABLE STANDARD(S):
MATERIAL		DRAWING REF NUMBER		
PC, STAINLESS STEEL 316/304		PC225SSLAS/ PC225SSLAS316		
A3	UNITS = MM	SCALE (UOS)	1.5	SHEET 5 OF 9

DISCLAIMER - THE DESIGN SUGGESTION IS PROVIDED FOR EVALUATION PURPOSES ONLY.
IT IS NOT TO BE CONSIDERED A FULL DESIGN AS WE ARE NOT THE CONSULTING ENGINEERS, WE ARE MANUFACTURERS. WE ARE NOT PRIVY TO ALL THE INFORMATION PERTAINING TO THIS MATTER AND WE HAVE NO CONTROL OVER THE PROJECT INSTALLATION OF THE PRODUCT. THE DESIGN SUGGESTION IS PROVIDED WITHOUT OBLIGATION. DESIGN IS TO BE CONFIRMED AND APPROVED BY THE ARCHITECT, HYDRAULICS ENGINEER, OR PROJECT MANAGER. ACCURATE MEASUREMENTS SHOULD BE CONFIRMED BY THE PERSON APPROVING THE DESIGN. ALLPROOF ACCEPTS NO LIABILITY FOR THE IMPROPER USE OF THE DESIGN SUGGESTION.

TOOL NUMBER	0.0
PART WEIGHT(GRAMS)	0.0
FILE	S/CAD FILES/2016/DIVERSE/ASSEM PC225