

DESCRIPTION	
CODE	FINISH
ALLFC40SS	STAINLESS STEEL
ALLFC40GALV	GLAVNISED STEEL

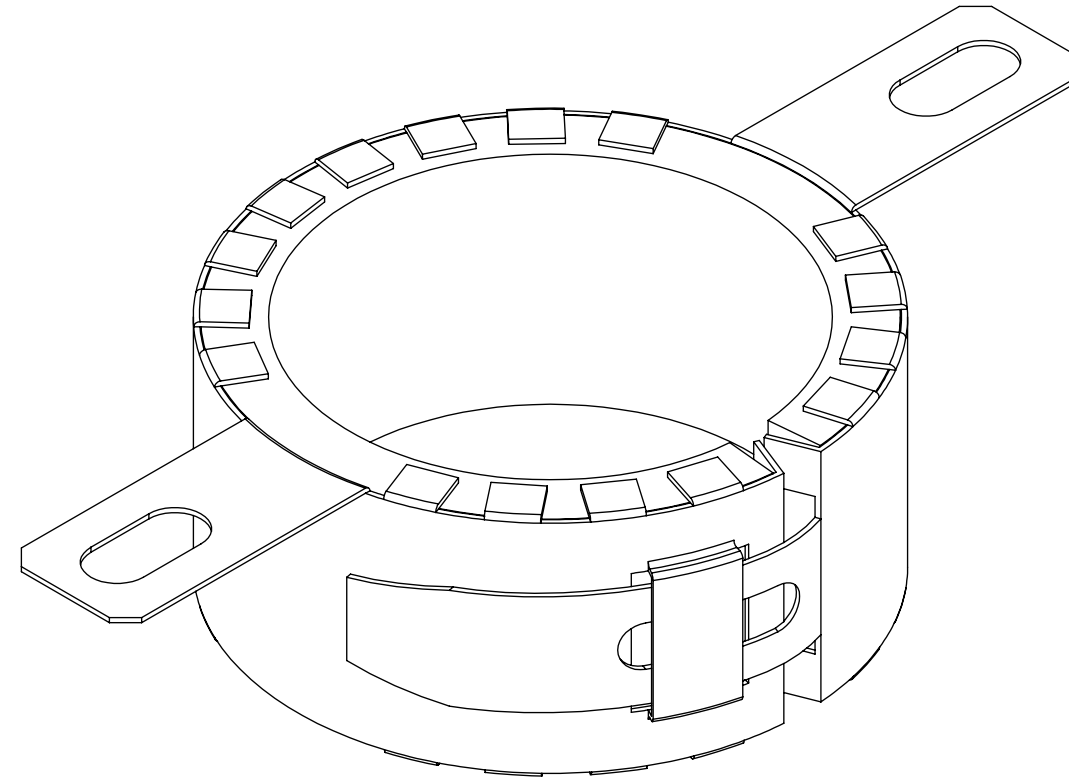

ISOMETRIC VIEW

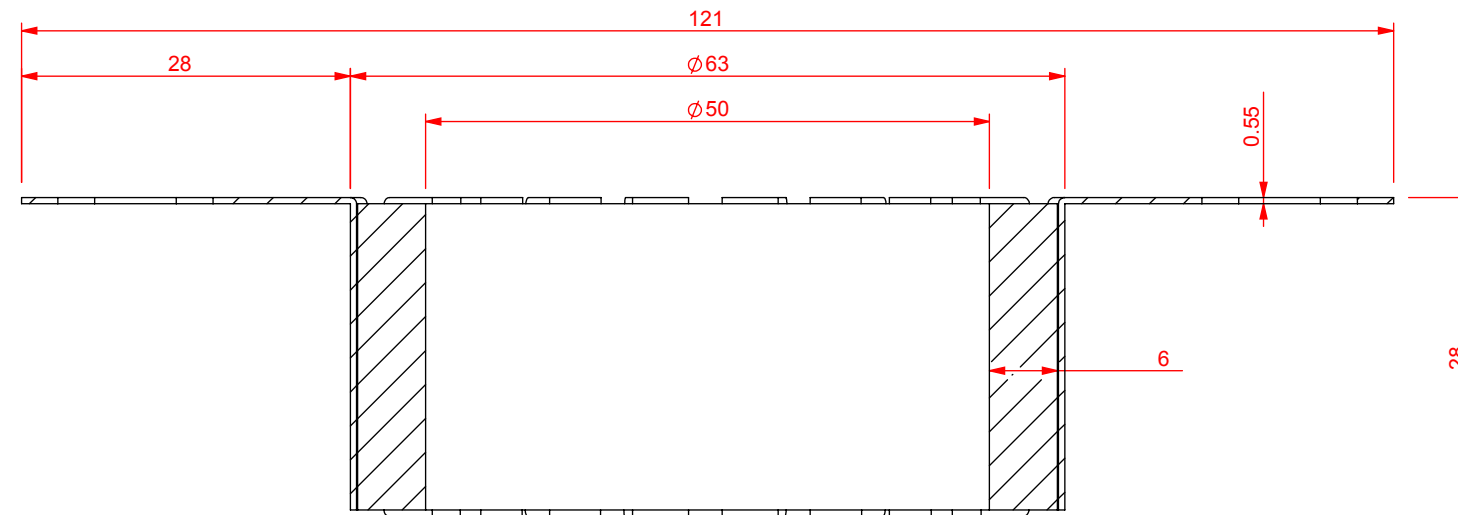

SECTION

REVISIONS	DRAWN	DATE	DO NOT SCALE DRAWING		ALLPROOF INDUSTRIES
			REQUESTED A.J	DATE 16.4.2013	
			DRAWN S.L.	DATE 16.4.2013	
			APPROVED	DATE	PART NUMBER ALLFC40
XXX	XXX	XXX	MATERIAL - 0.55 MM STEEL - 1/4 INCH INTUMESCENT(X1)		
TOOL NUMBER			0.0		SCALE : NTS (UOS)
PART WEIGHT(GRAMS)			0.0		
FILE			A3	UNITS = MM	SHEET 1 OF 4