

ALLPROOF INDUSTRIES DOMED VINYLRITE DRAIN 80MM MEMBRANE FINISH GUTTER OUTLET

Independent Flow Rate Test (Branz): 120 litres/minute under 50mm head of water

Specification Code	Description	Standard Finish
VR80DOME	80mm Domed drain with PVC base flange, clamp ring and dome	Cast Bronze clamp ring and dome

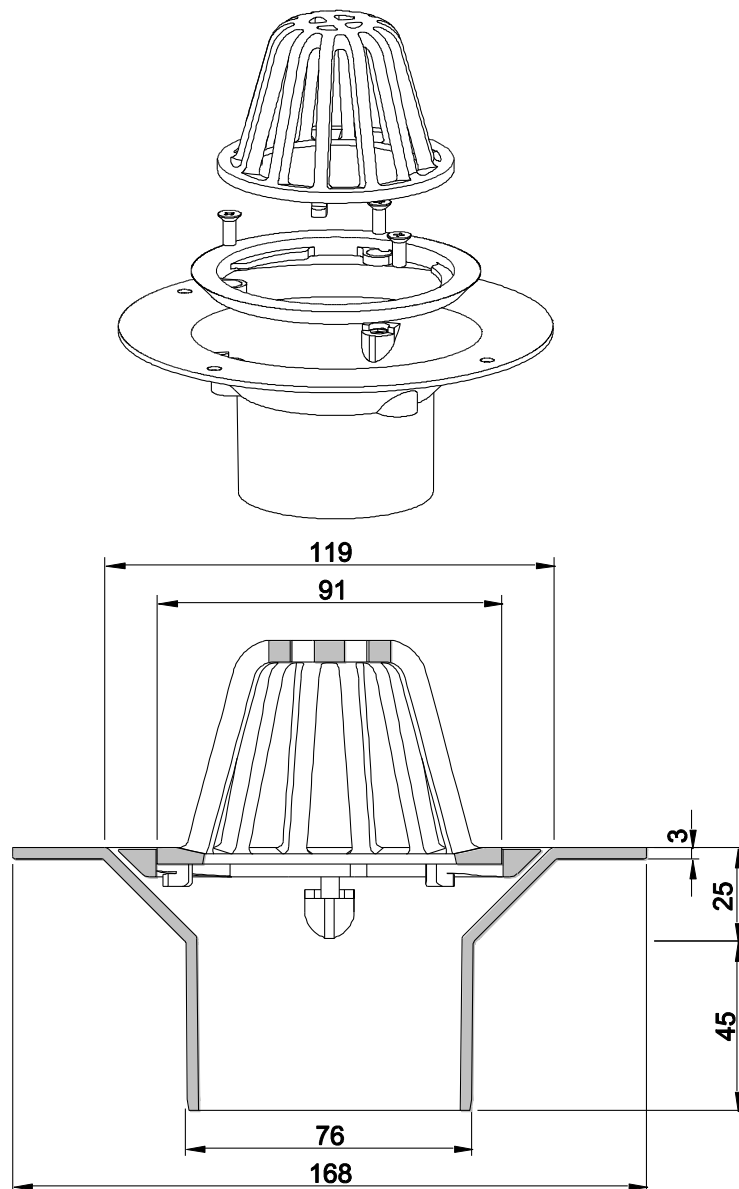

Due to Allproof Industries ongoing product development program product designs may be changed without notice