

ALLPROOF INDUSTRIES DOMED VINYLRITE DRAIN 50MM MEMBRANE FINISH GUTTER OUTLET

Independent Flow Rate Test (Branz): 103 litres/minute under 50mm head of water

Specification Code	Description	Standard Finish
VR50DOME	50mm Domed drain with PVC base flange, clamp ring and dome	Cast Bronze clamp ring and dome

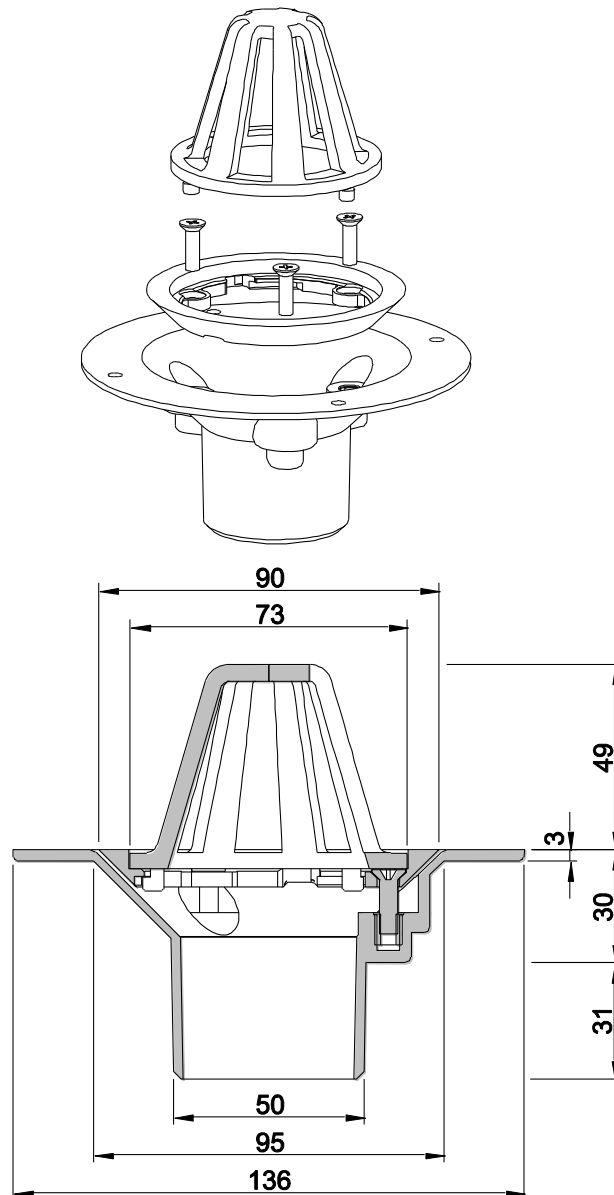

Due to Allproof Industries ongoing product development program product designs may be changed without notice