

ALLPROOF INDUSTRIES FLAT GRATE ROOF CLAMP RING DRAIN 80MM MEMBRANE FINISH ROOF OUTLET

Independent Flow Rate Test (Branz): 154 litres/minute under 50mm head of water

Specification Code	Description	Standard Finish
168.80FCR	80mm Flat Grate Roof drain including bronze base flange, clamp ring and grate	Cast Bronze clamp ring and grate

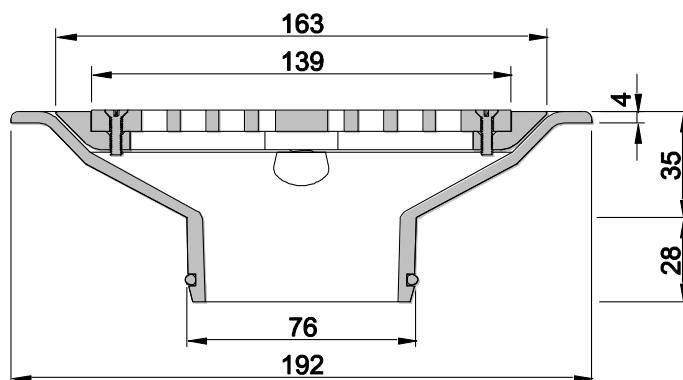
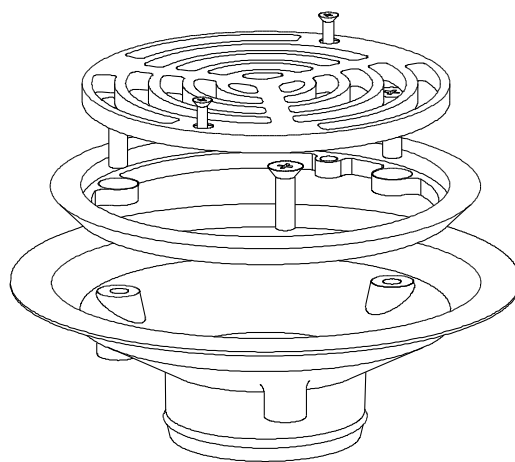

Due to Allproof Industries ongoing product development program product designs may be changed without notice