

**ALLPROOF INDUSTRIES DOMED ROOF CLAMP RING DRAIN
80MM MEMBRANE FINISH ROOF OUTLET**

Independent Flow Rate Test (Branz): 215 litres/minute under 50mm head of water

Specification Code	Description	Standard Finish
168.80DRCR	80mm Domed Roof drain including bronze flange, clamp ring and dome	Cast Bronze clamp ring and dome

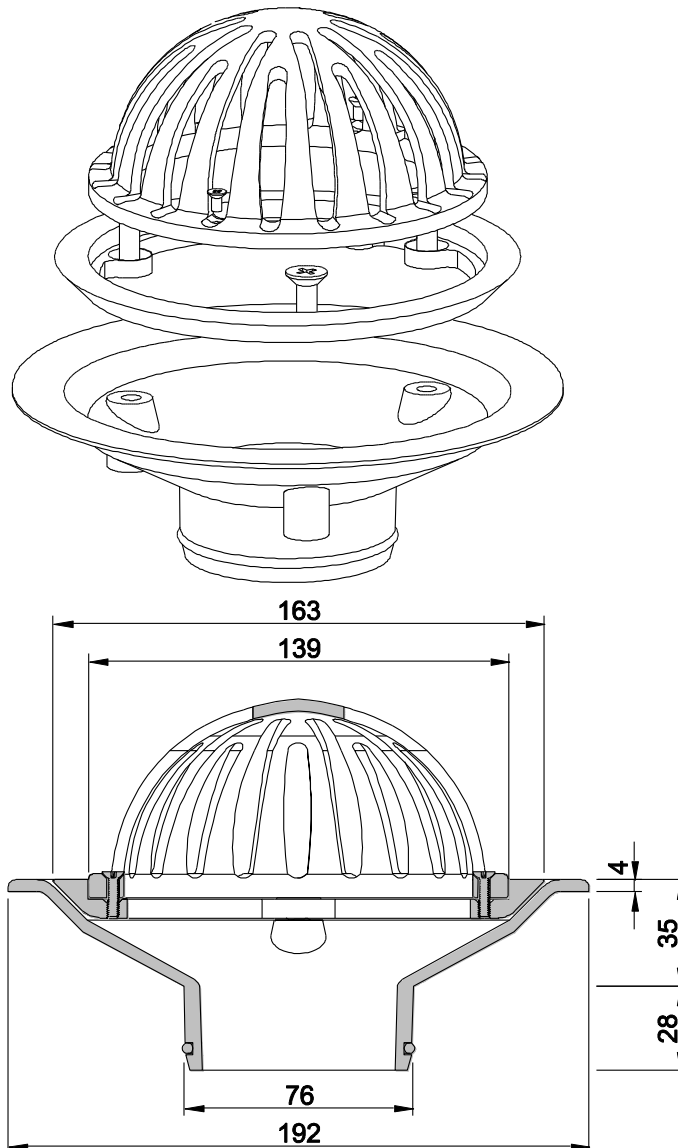

Due to Allproof Industries ongoing product development program product designs may be changed without notice