

ALLPROOF INDUSTRIES 80MM X 65MM FLOOR WASTE GULLY

Specification Code	Description	Standard Finish
FWG80.65	80mm x 65mm Floor Waste Gully	PVC

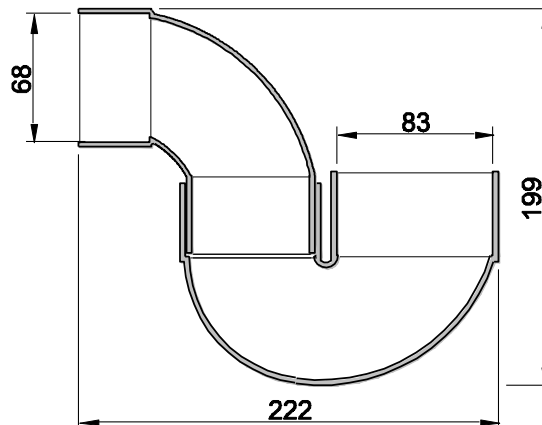
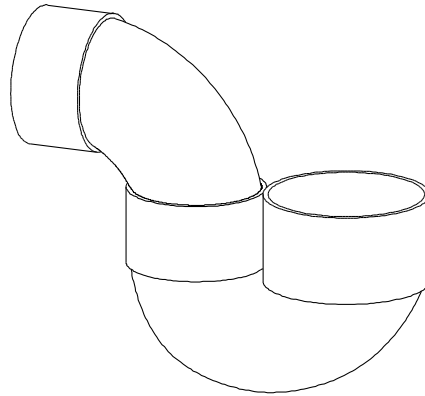

Due to Allproof Industries ongoing product development program product designs may be changed without notice