

ALLPROOF INDUSTRIES 80MM x 50MM FLOOR WASTE GULLY

Specification Code	Description	Standard Finish
FWG 80.50	80mm x 50mm Floor Waste Gully	PVC

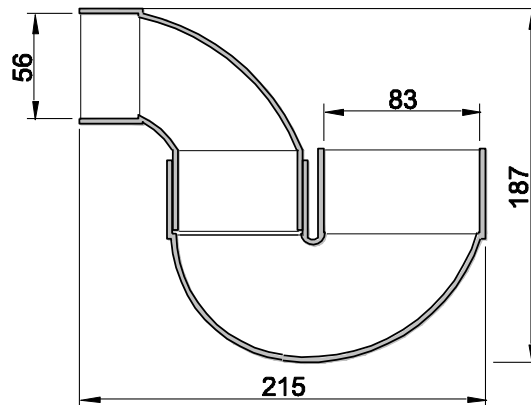
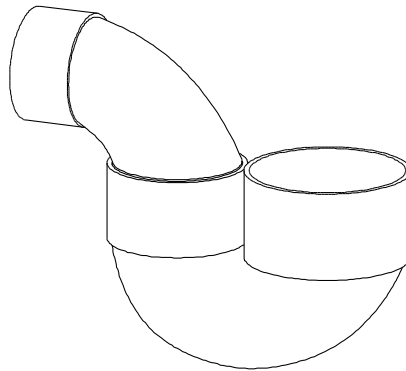

Due to Allproof Industries ongoing product development program product designs may be changed without notice