

## ALLPROOF INDUSTRIES 100MM X 65MM FLOOR WASTE GULLY

Specification Code	Description	Standard Finish
FWG100.65	100mm x 65mm Floor Waste Gully	PVC

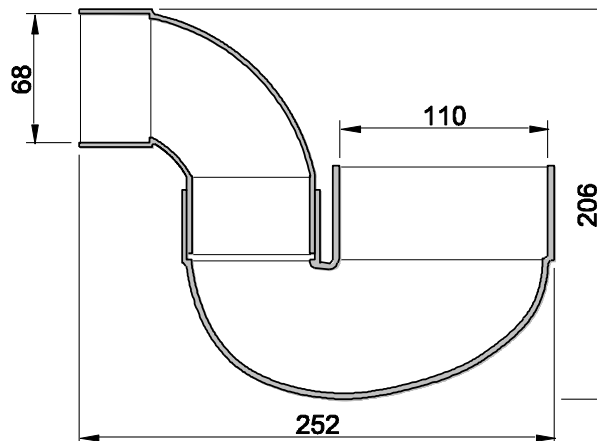
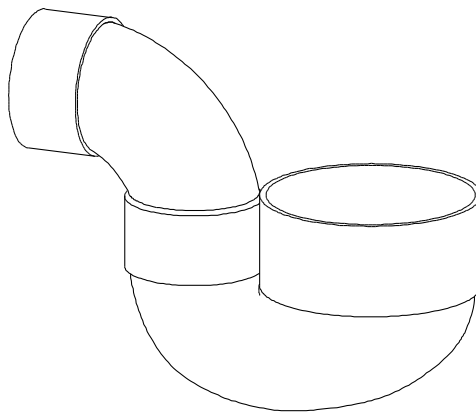

Due to Allproof Industries ongoing product development program product designs may be changed without notice