

ALLPROOF INDUSTRIES TILE FLOOR/BALCONY WASTE SYSTEM 50MM TILE FINISH COPPER FLANGE AND FLOOR GRATE

Independent Flow Rate Test (Branz): 38 litres/minute under 25mm head of water

Specification Code	Description	Standard Finish
LC71 & 168.80SCPT	50mm Copper leak control flange and square height adjustable floor grate	Square Chrome on Brass
LC71 & 168.80RCPT	50mm Copper leak control flange and round height adjustable floor grate	Round Chrome on Brass

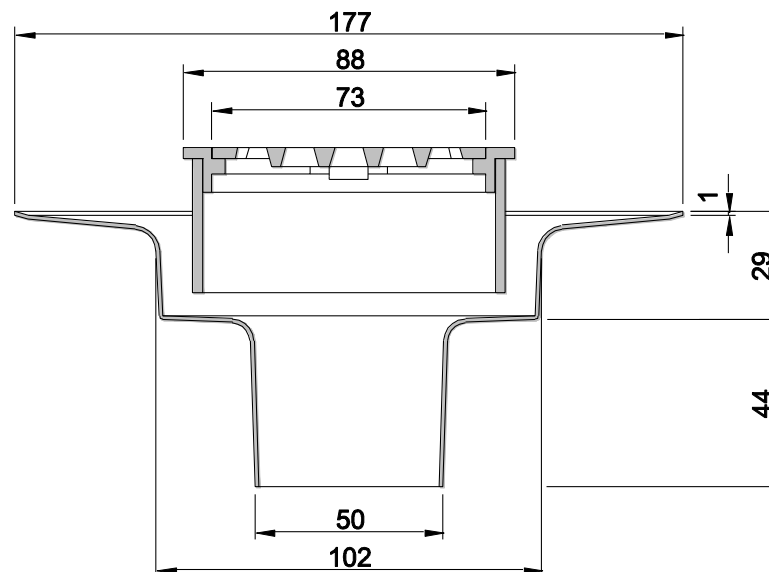
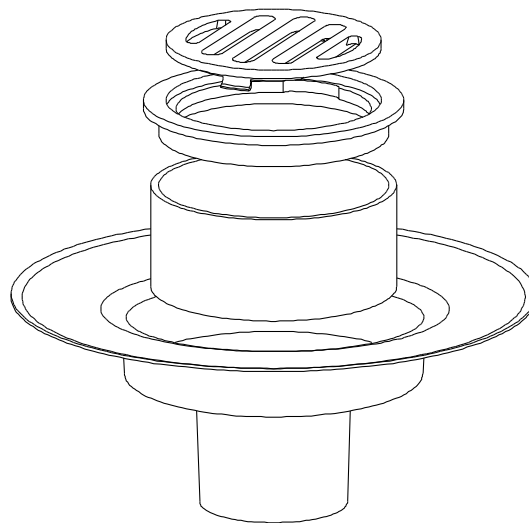

Due to Allproof Industries ongoing product development program product designs may be changed without notice