

ALLPROOF INDUSTRIES VINYLRITE CLEAN OUT 80MM VINYL/MEMBRANE FINISH INSPECTION

Specification Code	Description	Standard Finish
VR80CO CP	80mm VinylRite Clean Out including PVC base flange, clamp ring and lid	Chrome on Bronze clamp ring and lid
VR80CO BR	80mm VinylRite Clean Out including PVC base flange, clamp ring and lid	Machined Bronze clamp ring and lid
VR80CO NB	80mm VinylRite Clean Out including PVC base flange, clamp ring and lid	Machined Nickel Bronze clamp ring and lid

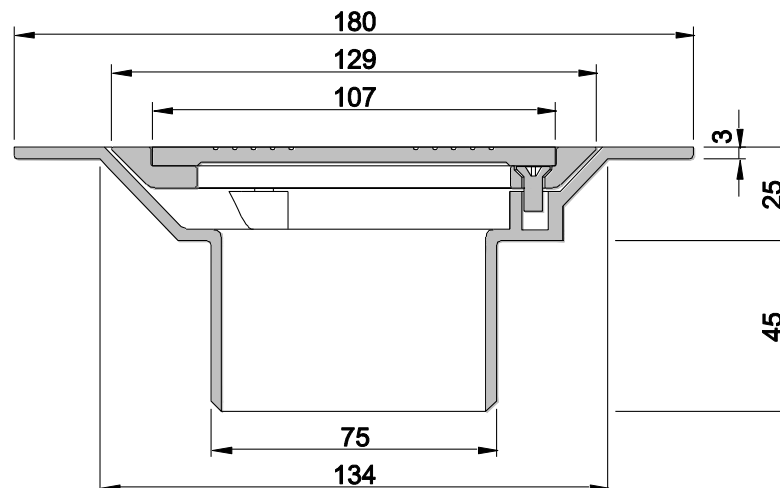
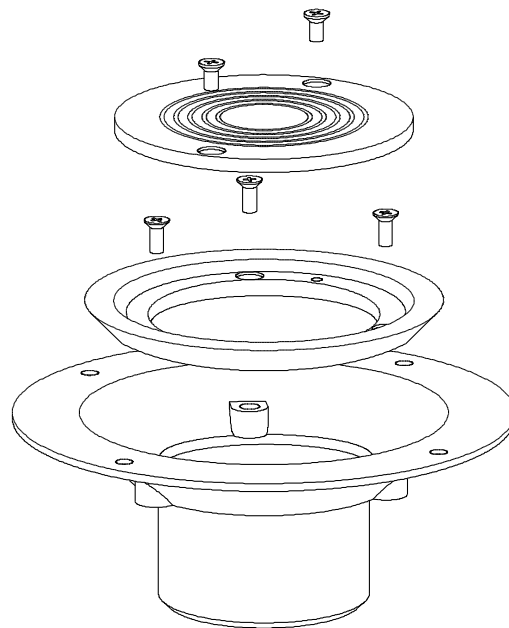

Due to Allproof Industries ongoing product development program product designs may be changed without notice