

**ALLPROOF INDUSTRIES BRONZE CLEAN OUT
65MM CONCRETE/TILE FINISH INSPECTION**

Specification Code	Description	Standard Finish
168.65BCO	65mm cast bronze clean out including o-ring seal	Machined bronze
168.65BCO CP	65mm chrome plated cast bronze clean out including o-ring seal	Chrome on bronze
168.65BCO NB	65mm chrome plated cast nickel bronze clean out including o-ring seal	Machined Nickel bronze

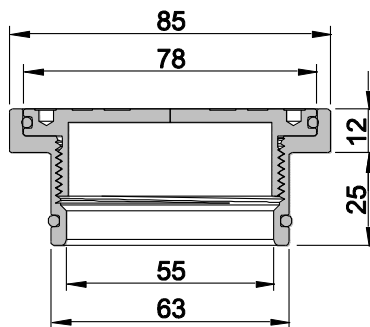
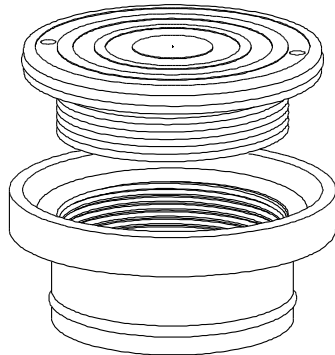

Due to Allproof Industries ongoing product development program product designs may be changed without notice